

Cobra5-VV R57 C46
 Date: 18.07.2006 10:35:12
 HDB electronic

V1/2 selected 12AX7EH
 V3/4 12AX7EH

Cobra5-VV
 Draw: 25.07.2005 07:23:53
HDB electronic

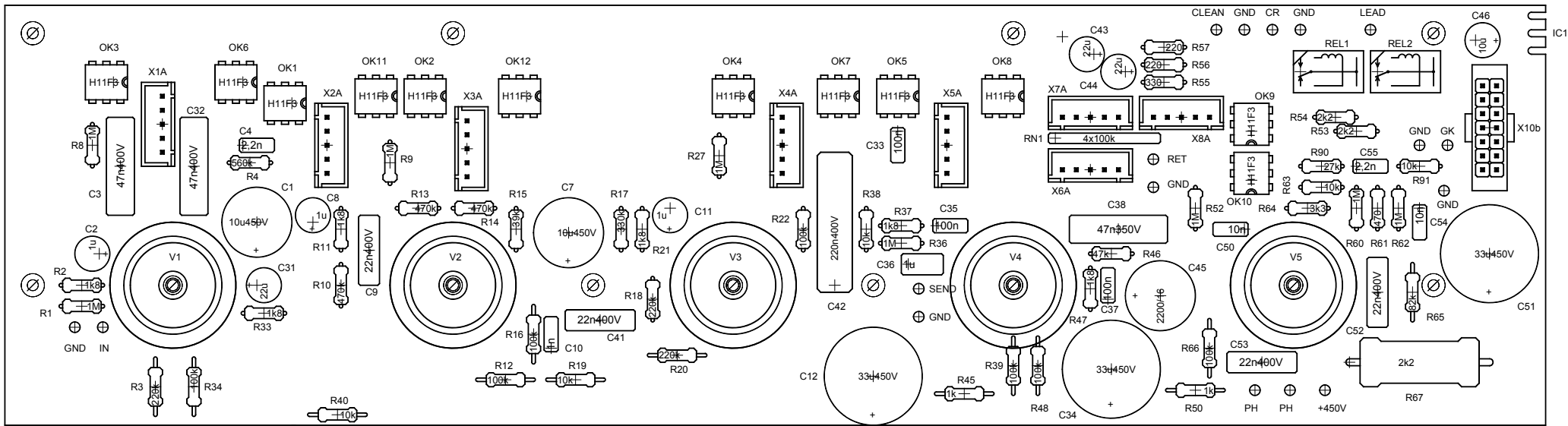

Cobra5-EQ
 Draw: 23.07.2005 09:46:59
HDB electronic

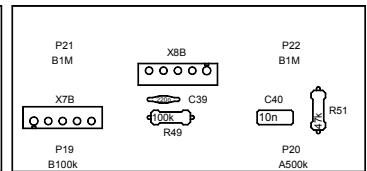
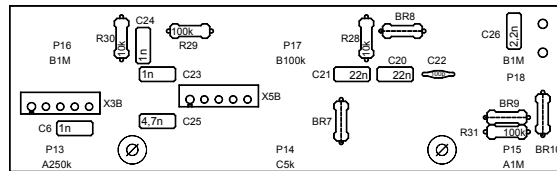
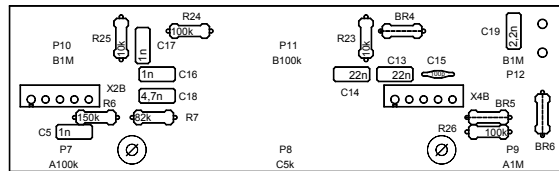
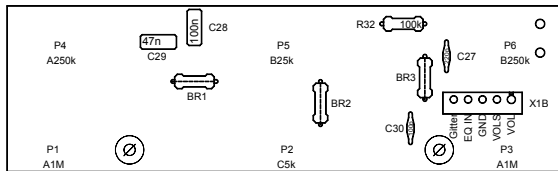

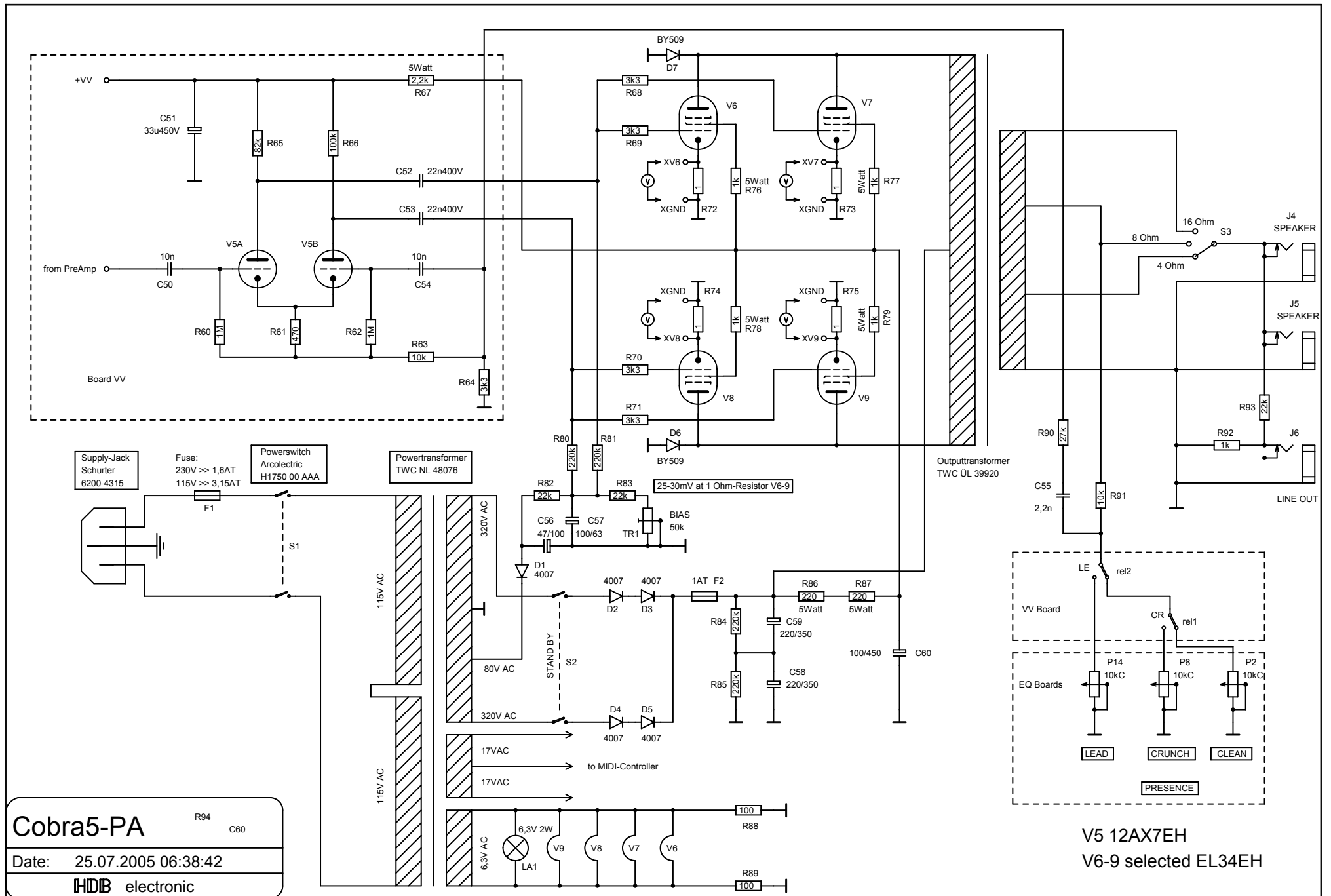

Cobra5-PA

R94

C60

Date: 25.07.2005 06:38:42

HDB electronic

V5 12AX7EH

V6-9 selected EL34EH

Cobra5-PA
 Draw: 22.07.2005 12:14:05
 HDB electronic

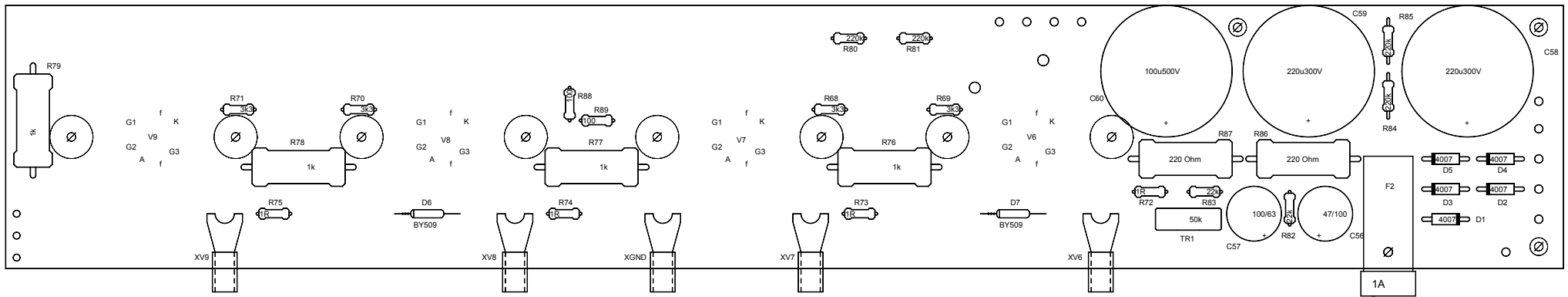

Cobra5-BU

Draw: 22.07.2005 10:27:53

HDB electronic

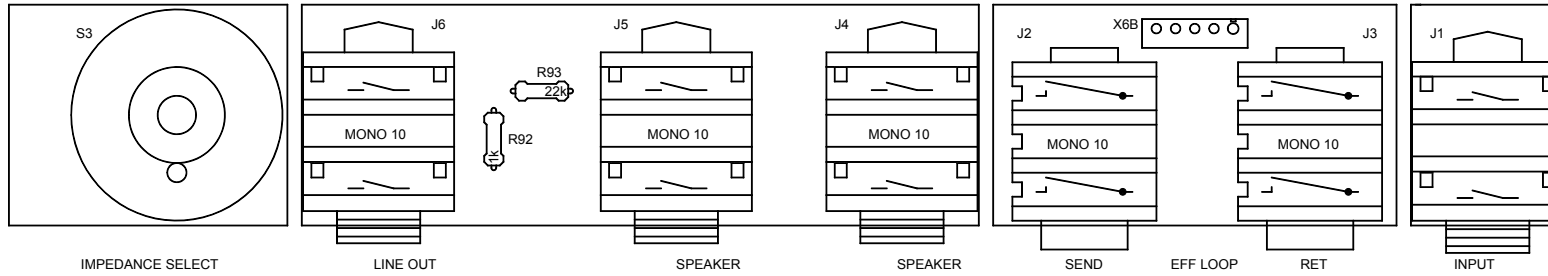

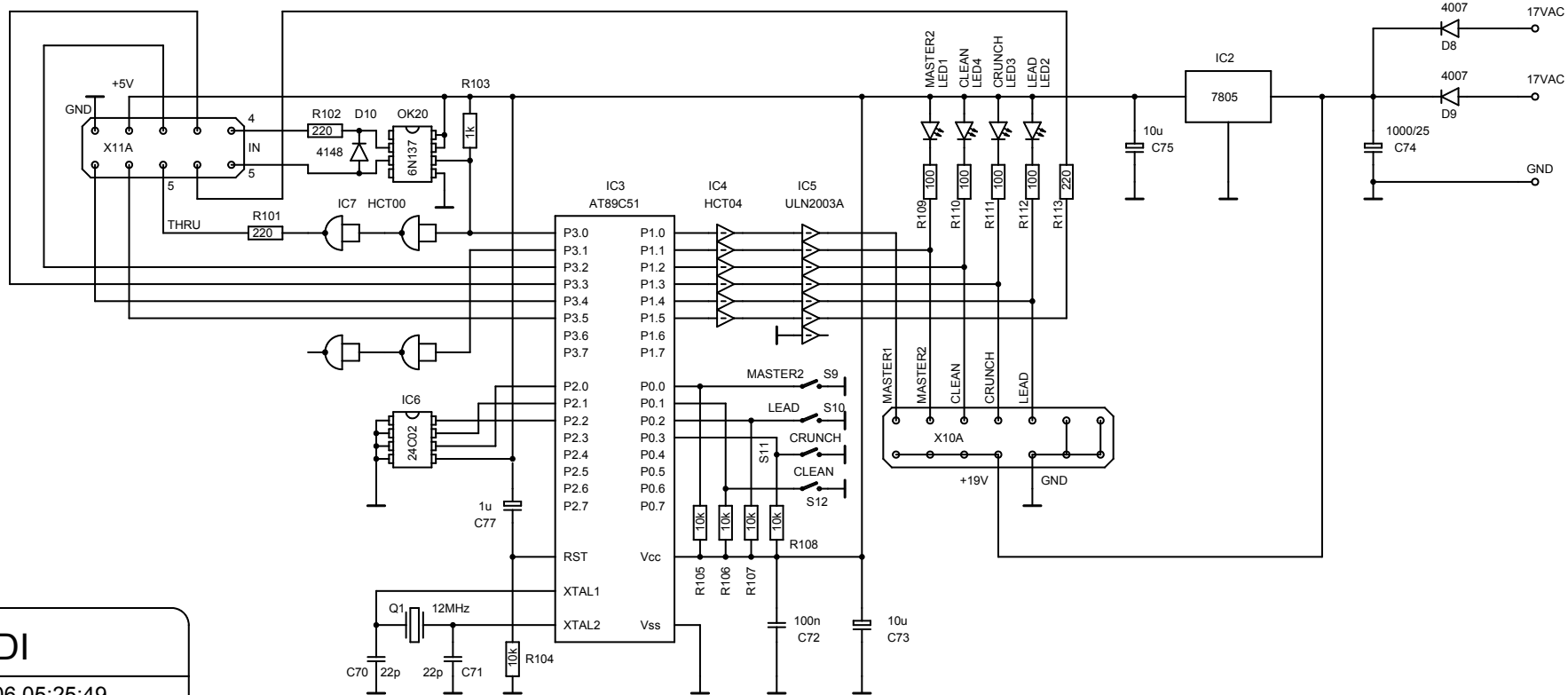
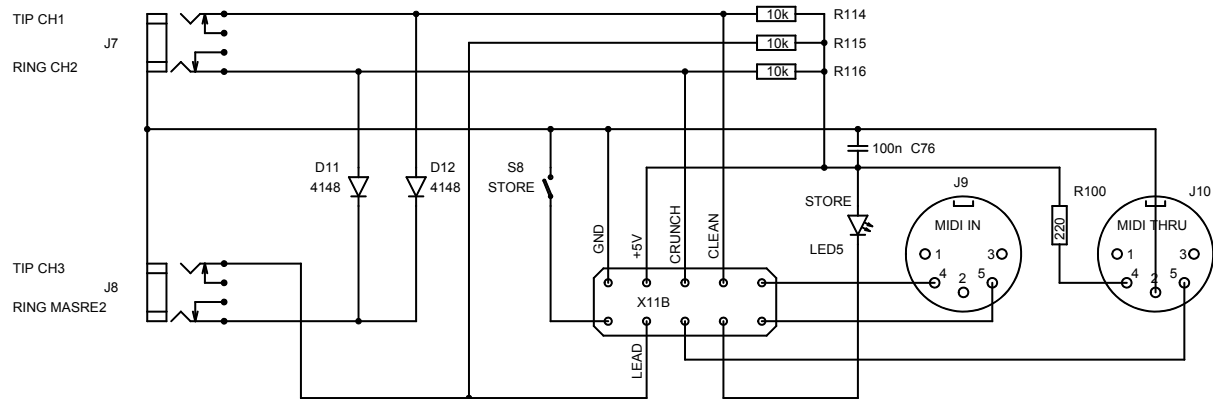

Cobra5-MIDI

Date: 23.11.2006 05:25:49

HDB electronic

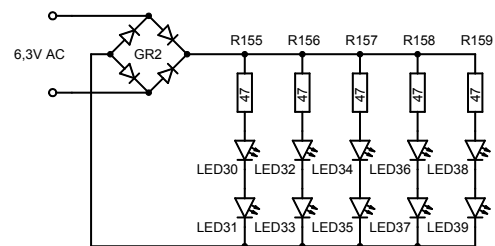
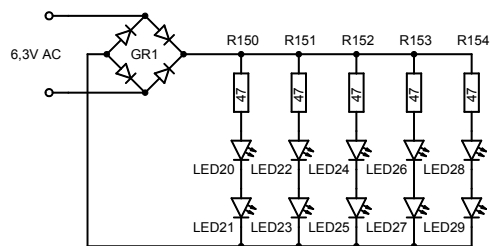

Cobra5-LED

Date: 25.07.2005 05:57:07

HDB electronic

Cobra5-LED

Draw: 23.07.2005 08:52:34

Plot: 23.11.2006 09:41:47

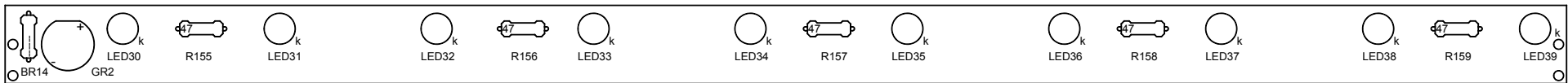
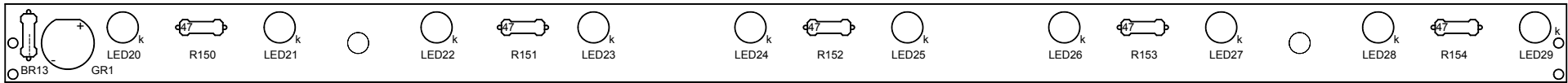

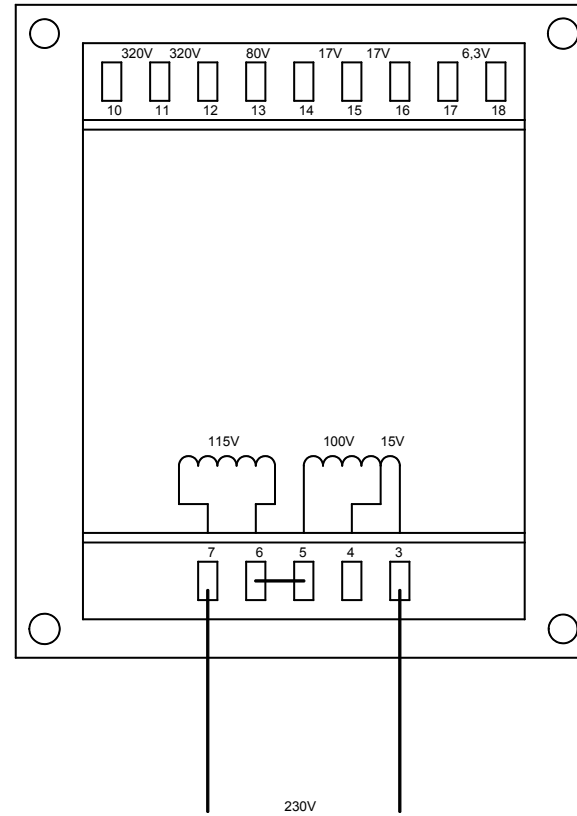
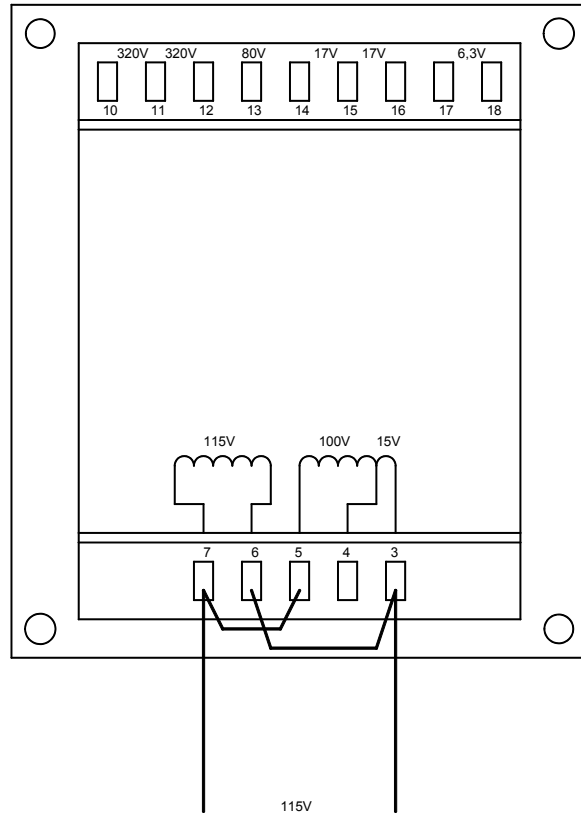

Cobra5-Trafo

Date: 03.06.2005 07:01:22

HDB electronic